

DuraHold®
Single Depth
System Components
Specification
Design
Installation
Cross Section Drawings
Design Detail Drawings
Case Studies
Brochure
Locate Manufacturer
Crib
Reinforced

DuraHold® System Components

Single Depth

<p>DuraHold Coping Unit</p> <p>305mm x 610mm x 1830mm (height x depth x length) Nominal Imperial Measurements: 12" x 24" x 72" Weight – 780 kg (1720 lbs)</p> <p>DuraHold Half Coping Unit</p> <p>305mm x 610mm x 915mm (height x depth x length) Nominal Imperial Measurements: 12" x 24" x 36" Weight – 390 kg (860 lbs)</p>	
<p>DuraHold Standard Unit</p> <p>305mm x 610mm x 1830mm (height x depth x length) Nominal Imperial Measurements: 12" x 24" x 72" Weight – 790 kg (1740 lbs)</p> <p>DuraHold Half Standard Unit</p> <p>305mm x 610mm x 915mm (height x depth x length) Nominal Imperial Measurements: 12" x 24" x 36" Weight – 395 kg (870 lbs)</p>	
<p>DuraHold Corner Unit</p> <p>305mm x 610mm x 1525mm (height x depth x length) Nominal Imperial Measurements: 12" x 24" x 60" Weight – 658 kg (1450 lbs)</p>	

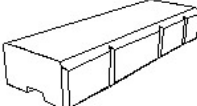
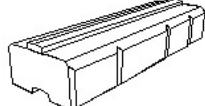
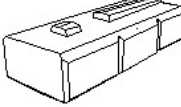
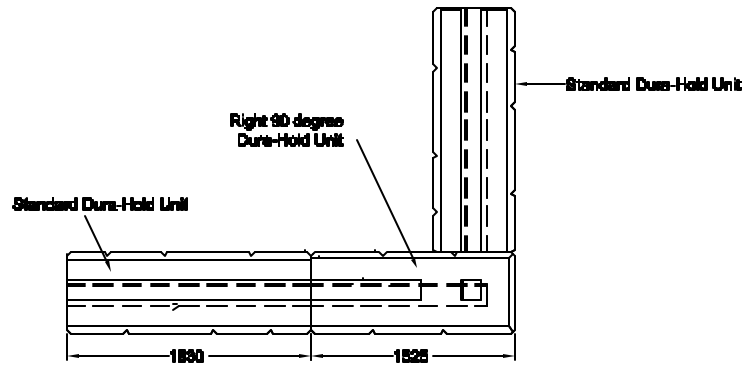

COURSE "A"

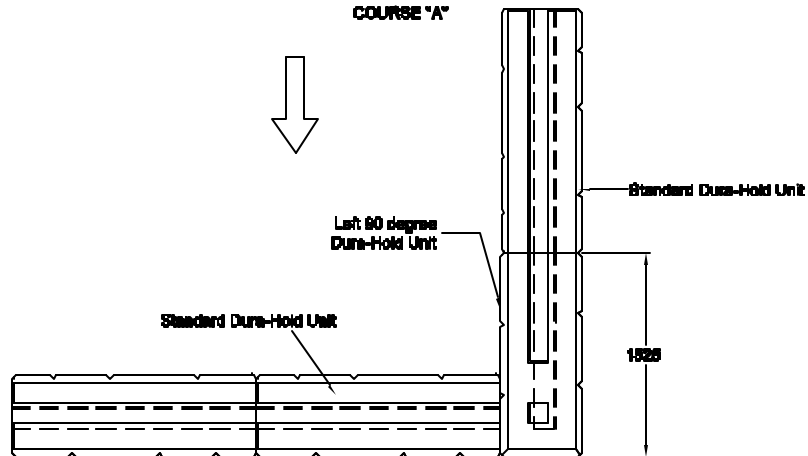
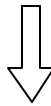

COURSE "B"

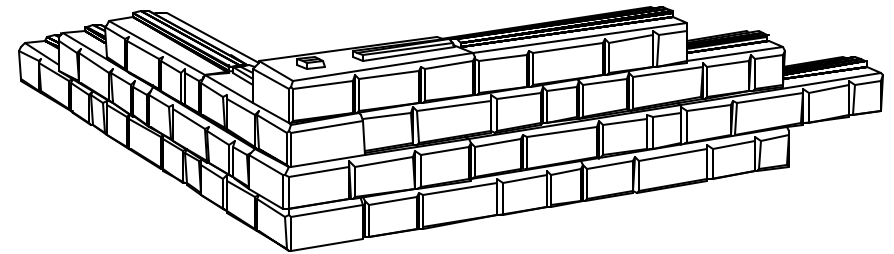

RisiStone[®]
retaining wall systems

6500 Leslie Street, Suite 300
Thornhill, Ontario
Canada, L3T 7M6
Tel 905.882.5896 Fax 905.882.4558
<http://www.risistone.com>
©2008 Risi Stone Systems

DuraHold[®]
90 Deg. Outside Corner

DH1GDET001.DWG

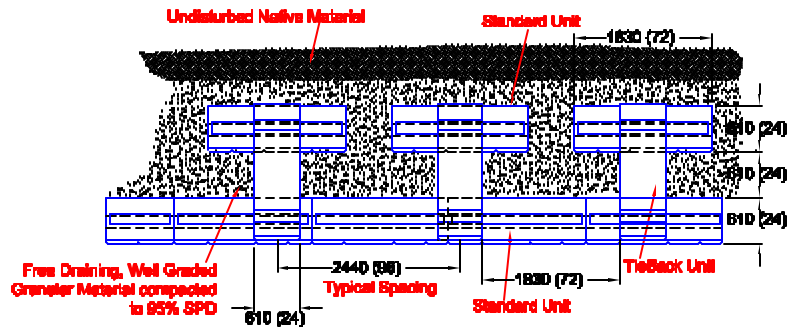

TYPICAL SINGLE CRIB PLAN

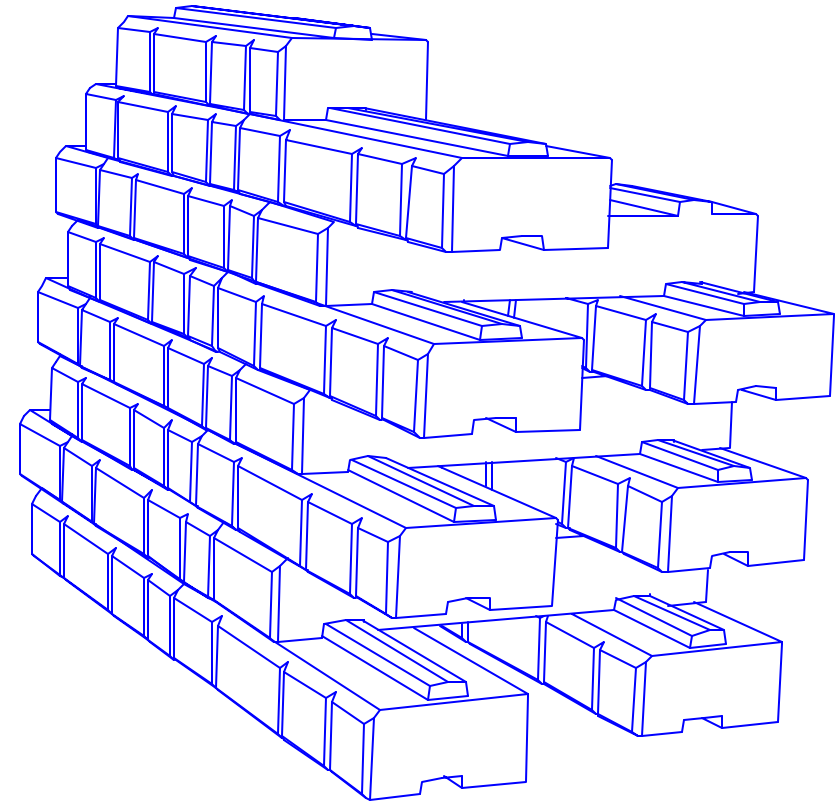
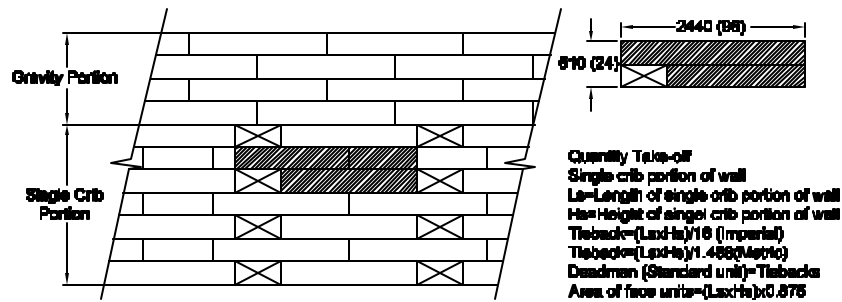

TYPICAL SINGLE 3D VIEW



RisiStone[®]
retaining wall systems

6500 Leslie Street, Suite 390
 Thornhill, Ontario
 Canada, L3T 7M6
 Tel 905.882.5898 Fax 905.882.4558
<http://www.risistone.com>
©2008 Risi Stone Systems

DuraHold[®]

Crib Structure
 Single Crib Geometry

DH1CDET004.DWG

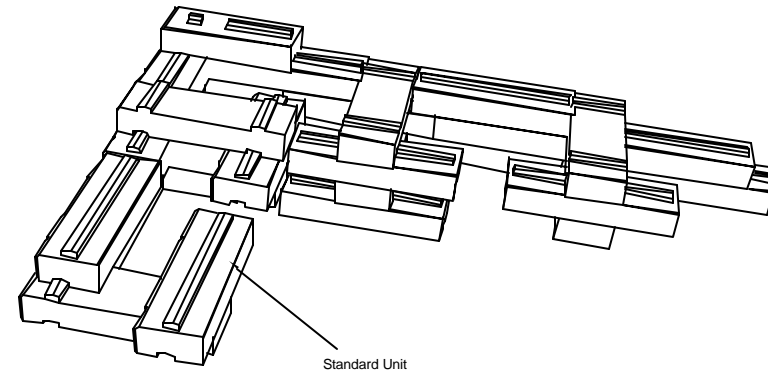
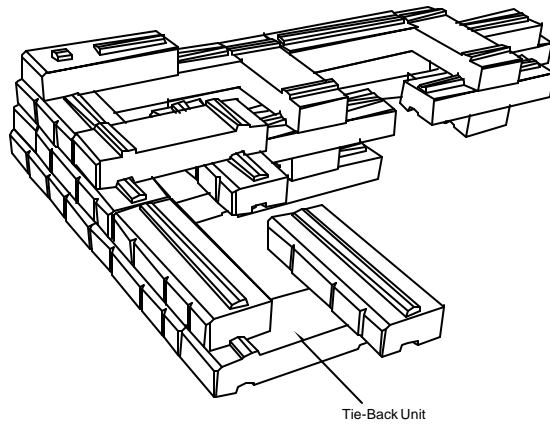
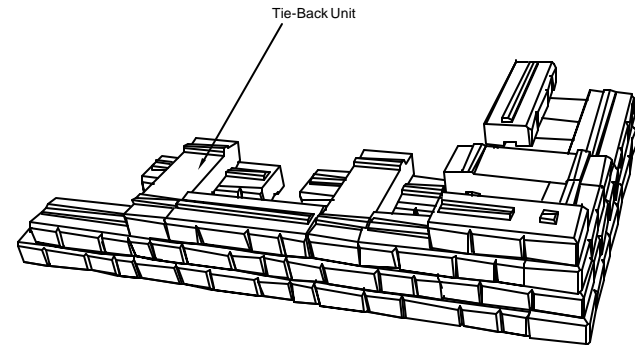
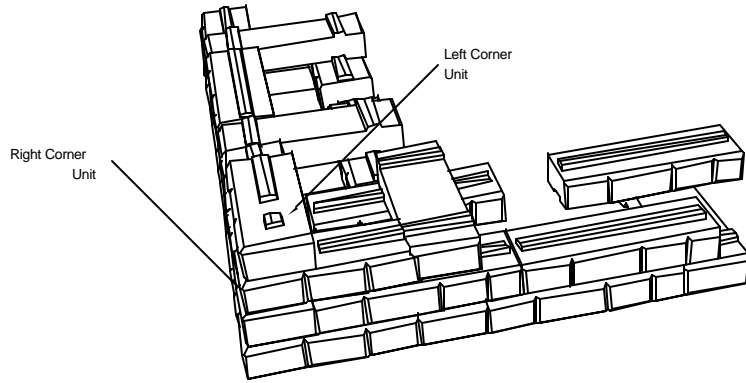

RisiStone
retaining wall systems

8500 Leslie Street, Suite 390
Thornhill, Ontario
Canada, L3T 7M8
Tel 905.882.5898 Fax 905.882.4556
<http://www.risistone.com>

DuraHold[®]
Crib Structure
90 Degree Outside Corner

DH1CDET002.DWG